

SPP-3610
Pull-Out Kitchen Faucet
Installation Guide

Model Numbers	Specification
<input type="checkbox"/> SPP-3610 <i>Pull-Out Kitchen Faucet</i>	Pull-Out Kitchen Faucet shall include single hole mount configuration, ceramic cartridge, braided hose connections and standard 2.2 gpm (8.3 L/min) aerator. Faucet shall be made from metal construction, plated in standard polished chrome finish.
Modifications	
<input type="checkbox"/> -1.5 <i>1.5 gpm (5.7 L/min) flow restrictor</i> <input type="checkbox"/> -BBZ <i>Brushed Bronze finish</i> <input type="checkbox"/> -MB <i>Matte Black finish</i> <input type="checkbox"/> -STS <i>Stainless Steel finish</i>	
<p>Note: Append appropriate -suffix to model number.</p>	
Compliance	Warranty
-ASME A112.18.1/CSA B125.1 -NSF/ANSI 61.9, NSF/ANSI 372	 <p>Limited Lifetime - to the original end purchaser in consumer/residential installations. 5 Years - for industrial/commercial installations. Refer to www.symmons.com/warranty for complete warranty information.</p>

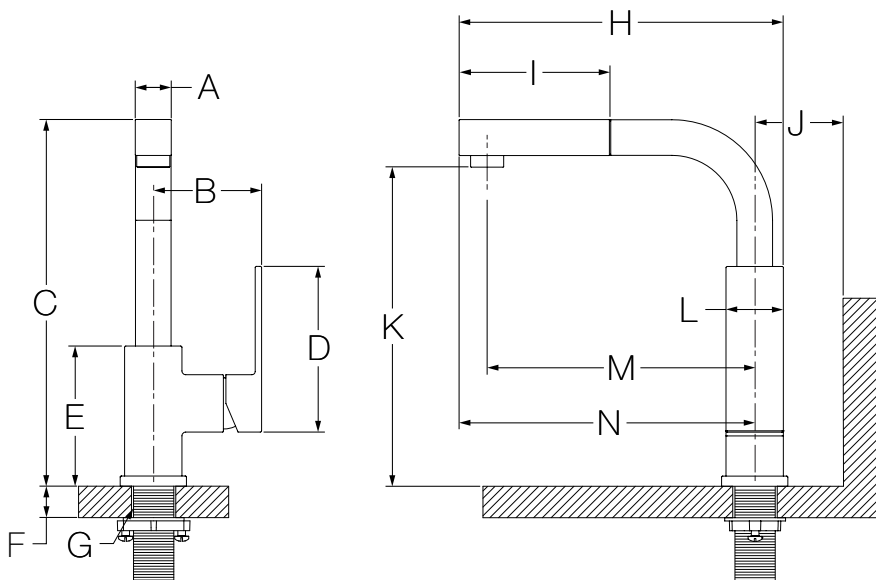

Dimensions



Measurements	
A	1-1/8", 29 mm
B	3-3/8", 86 mm
C	11-5/16", 287 mm
D	5-1/8", 130 mm
E	4-5/16", 110 mm
F	Deck Thickness Ref. Max. 2-1/2", 64 mm
G	Hole Size Min. Ø 1-3/8", 35 mm Max. Ø 1-1/2", 38 mm
H	10", 254 mm
I	4-5/8", 117 mm
J	To Backsplash 4", 102 mm
K	9-7/8", 251 mm
L	1-3/4", 44 mm
M	8-1/4", 210 mm
N	9-1/8", 232 mm

Notes:

- 1) Hoses removed for clarity.
- 2) Dimensions subject to change without notice.

Parts Breakdown

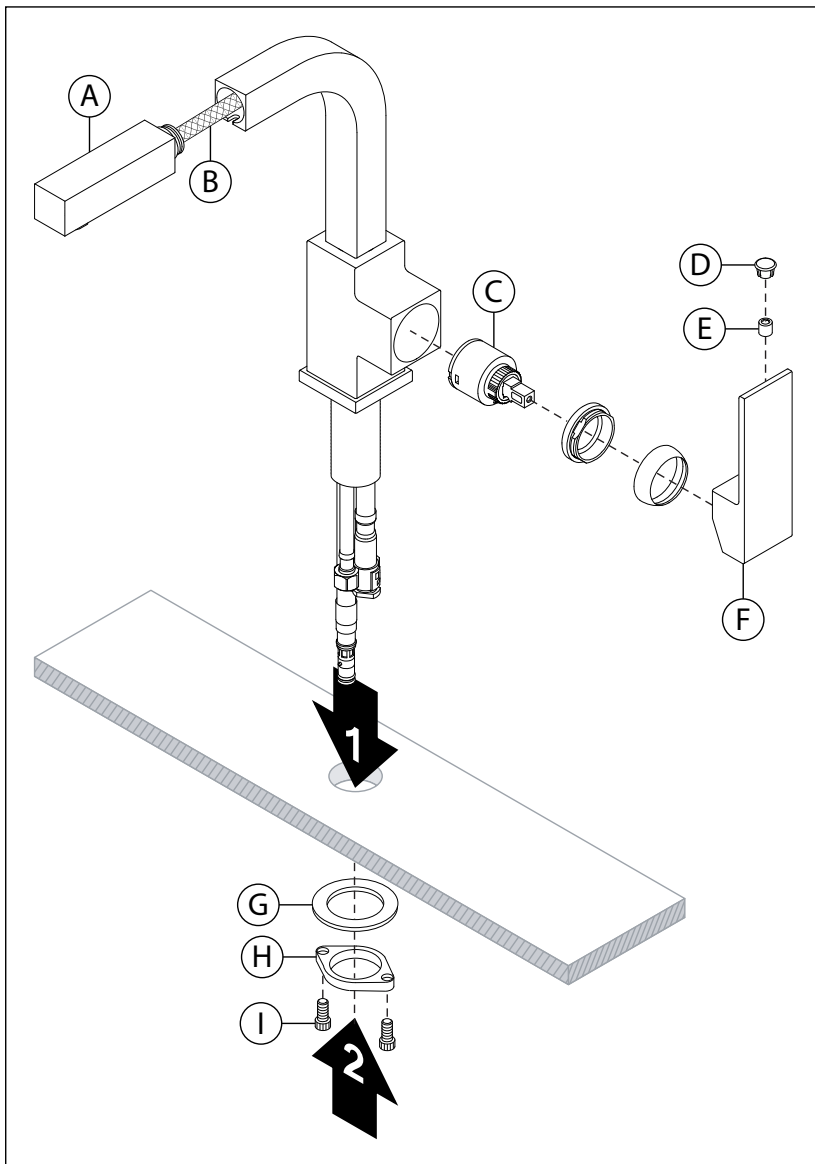





Replacement Parts

Item	Description	Part Number
A	Pull-Out Wand	RK-026
B	Pull-Out Wand Hose	RK-032
C	Cartridge	KN-4
D	Plug Button	RK-027
E	Set Screw	
F	Handle	
G	Mounting Washer	RK-028
H	Mounting Nut	
I	Mounting Screws	

***Note:** Append appropriate -suffix to repair part number for premium finish.

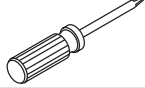
Tools Required for Installation

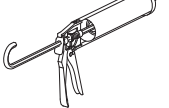
Adjustable Wrench	
Allen Wrench: Handle (2.5 mm)	
Phillips Head Screwdriver	
Plumber Tape	
Silicone	

Installation Notes:

- 1) Apply a bead of clear silicone around the perimeter of all faucet trim installed to deck surface.
- 2) Apply plumber tape to threaded connections as necessary. DO NOT use plumber tape on fittings with face seal washers or o-rings.
- 3) DO NOT OVERTIGHTEN fittings with face seal washers or o-rings.

⚠ WARNING: This product can expose you to chemicals including lead, which is known to the state of California to cause cancer, birth defects, or other reproductive harm. For more information, go to www.P65Warnings.ca.gov.